

# CSEN & Senior Design

Overview, Faculty Advisors, and Specific Project Areas

*The following are example projects suggested by the individual CSEN faculty members listed. Some offer opportunities for interdisciplinary groups, and some are in collaboration with existing collaborators with real-world problems that are looking for solutions, but all are examples and are definitely not an exhaustive list of opportunities.*

*So please feel free to contact individual faculty members in CSEN about potential projects.*

# CSEN Faculty Advisors

Full List

- . **Maya Ackerman**
- . **Salem Al-Agtash**
- . **Ahmed Amer**
- . **David Anastasiu**
- . **Darren Atkinson**
- . **Younghyun Cho**
- . **Sean Choi**
- . **Ruth Davis**
- . **Behnam Dezfouli**
- . **Farokh Eskafi**
- . **Yi Fang**
- . **Silvia Figueira**
- . **Sharon Hsiao**
- . **Shiva Jahangiri**
- . **Max Kreminski**
- . **Xiang Li**
- . **Nam Ling**
- . **Yuhong Liu**
- . **Ying Liu**
- . **Kai Lukoff**
- . **Angela Musurlian**
- . **Weijia Shang**

# Specific Proposals

List of focus areas & specific project suggestions

# Presentation Order

- **David Anastasiu**
- **Younghyun Cho**
- **Silvia Figueira**
- **Sharon Hsiao**
- **Kai Lukoff**
- **Sharon Hsiao**
- **Xiang Li**
- **Max Kreminski**
- **Ying Liu**
- **Shiva Jahangiri**

- **David Anastasiu**

# Senior Design

Anastasiu Lab Edition





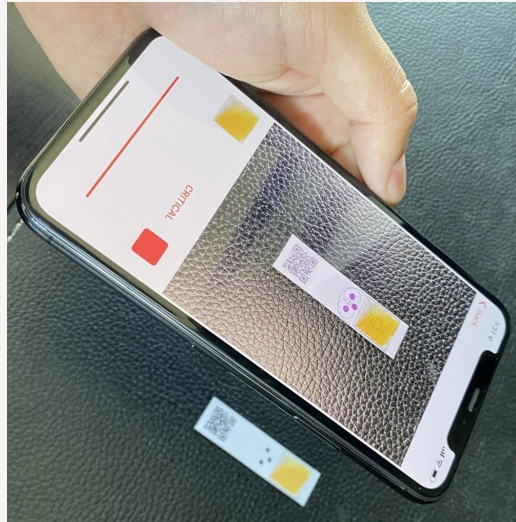

# Project 1: Kidney Health Prediction

- Design and implement Android-based experimentation application
- Computer vision algorithms for test strip localization
- Machine learning/deep learning prediction algorithms
- Dynamic model loading/update
- Backend NoSQL or DB storage
- Web-based export/query tool

## Project 2: Color Constancy

- Computer Vision/Machine Learning research project
- Learn transformation that will adjust pixel values to perceive the same color tones irrespective of illumination or background
- Application to Kidney Health Prediction

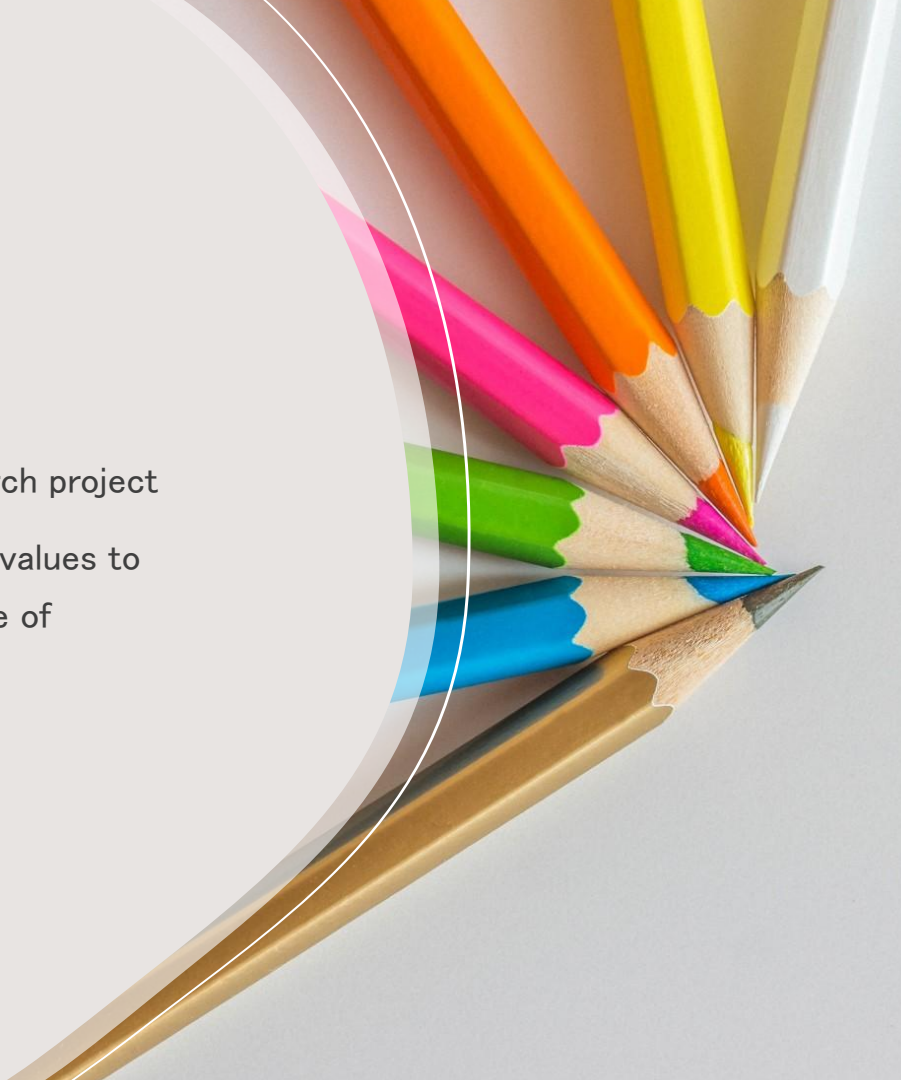



## Project 3: AI City Challenge

- Deep Learning-based algorithmic design
- Driver activity prediction
- Product counting and recognition
- Multi-class corridor vehicle counting
- Motorcycle helmet rule
- <https://www.aicitychallenge.org/>

## Project 4: Machine Learning

- BYOP (Bring Your Own Project)
- Algorithmic design and/or interesting application of data mining, machine learning, deep learning, high performance computing
- Not just a simple project you would do in class





## Contact

David C. Anastasiu

[danastasiu@scu.edu](mailto:danastasiu@scu.edu)

Office Hours:

Tue, 11:30—12:30, Bergin 100

- **Younghyun Cho**

- (younghyun@berkeley.edu)



SANTA CLARA UNIVERSITY  
SCHOOL OF ENGINEERING



# Design projects with Younghyun Cho

**Dr. Younghyun Cho**  
younghyun@berkeley.edu

**April 24, 2023**



- **Silvia Figueira**



# Prof. Figueira

## **Digital Transformation Projects**

Web/Mobile projects to help organizations that operate in low-resource communities embrace technology

Real-world collaborations:

Non-profit organizations or social enterprises

Locations

Africa, Latin America, California

- **Sharon Hsiao**



# 1. Waste Sorting Game Design

## 2. Alumni network + campus tour in AR

**Dr. Sharon Hsiao**  
[ihsiao@scu.edu](mailto:ihsiao@scu.edu)

**April 17, 2023**



# Waste Sorting Game Design

- Create a fun and engaging experience to help people learn proper waste sorting.

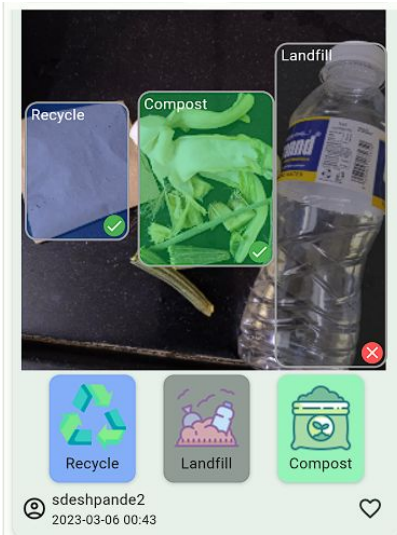
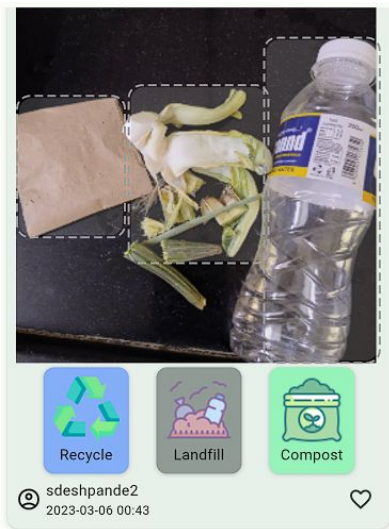

- How to verify the correctness?
- What gaming/competition can engage more contribution?
- ...



# Waste Sorting Game Design

## Required skills

- Web programming skills
- Creativity

## Where you start

- <https://webpages.scu.edu/ftp/ihsiao/Research/EdTech/WasteMgt.html>



# Alumni network + campus tour in AR

## Required skills

- Web programming skills (HTML, CSS, JS)
- Creativity

## Where you start

- <https://jeromeetienne.github.io/AR.js/>

- **Xiang Li**



## Xiang Li, Assistant Professor

- Research interests
    - Machine learning
    - Optimization and network theory
    - Social networks
    - Algorithms
  - Find more at <https://www.cse.scu.edu/~xli/> or contact xli8@scu.edu
-



- **Kai Lukoff**

More info



# Human-Computer Interaction (HCI) Lab

0:00



👋 Hi, I'm Kai Lukoff. Assistant Professor in  
Computer Science and Engineering

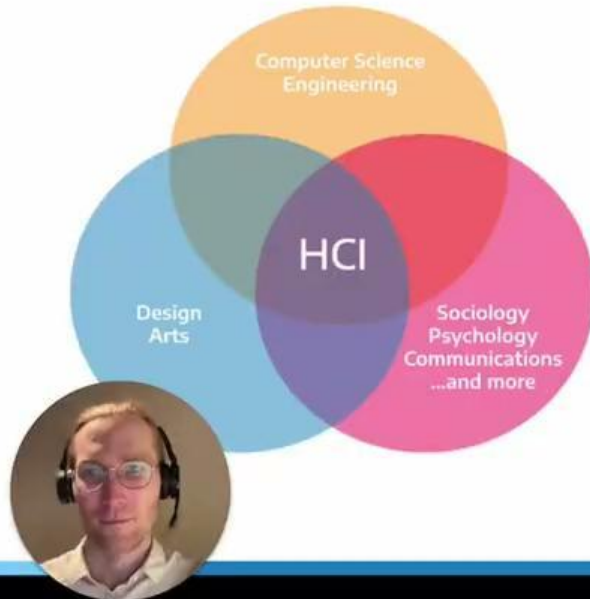

- Recruiting students for 2 senior design projects
- All projects utilize technical, design, *and* social science skills!

- **Max Kreminski**

# Senior Design Projects in the Creativity Support Lab

Max Kreminski

SCU SoE Junior Convocation, 2023-04-24

# Students in my lab design and build **creativity support tools.**

*software tools that support human creators  
(e.g., writers, designers, artists...)*

We work at the intersection of  
**artificial intelligence** and  
**human-computer interaction.**

# Major project areas: AI-based tools for...

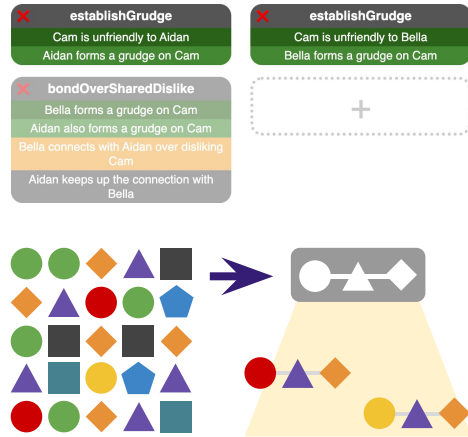

Storytelling

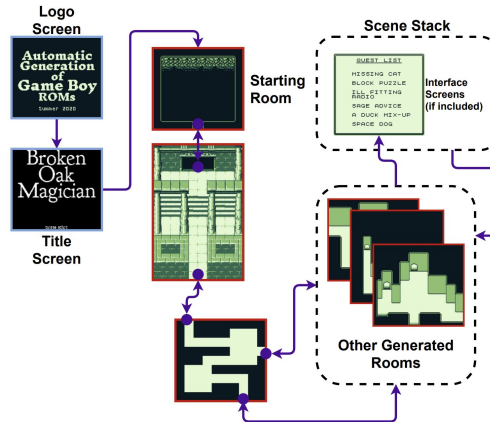

Game design

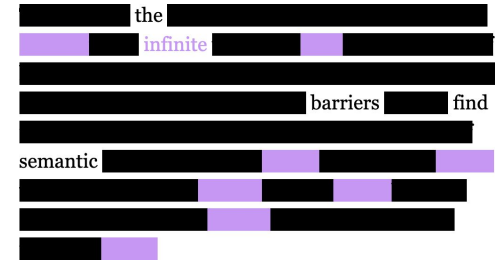

Poetry

...or pitch your own (in a creative domain of your choice)

# Skills you'll learn or develop include...

...building user interfaces in HTML,  
CSS, and JavaScript

...working with large language models  
and other recently introduced  
generative AI technologies

...studying human users of software  
*(right: visualizations of user interaction with a  
poetry creation tool)*

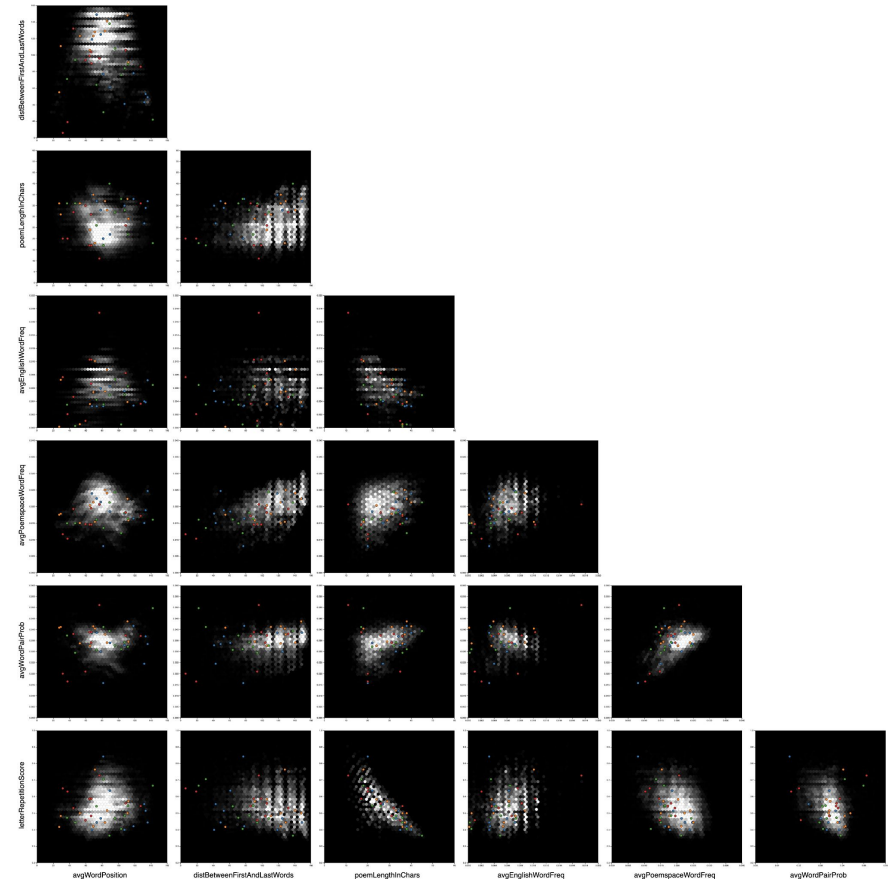



# Interested? Get in touch!

- Max Kreminski (they/them)
- [mkreminski@scu.edu](mailto:mkreminski@scu.edu)
- [mkremins.github.io](https://mkremins.github.io)  
*(for more information on past projects)*
- Spring '23 office hours: 3:30-5pm MW, Heafey 207  
*(drop-ins welcome!)*
- Or come say hi after the presentations  
*(right: a photo of me)*



. **Ying Liu**



# Senior Design Project

**Dr. Ying Liu**

**Assistant Professor**

**The Video and Image Processing (VIP) Laboratory  
Department of Computer Science and Engineering**

**[yliu15@scu.edu](mailto:yliu15@scu.edu)**

**<https://www.cse.scu.edu/~yliu1/index.html>**



# Project 1: Deep Learning-Based Image Super-Resolution

- Image Super-Resolution: the task is to convert a low-resolution image to a high-resolution image, such that human can view it more clearly.
- [NTIRE2023: New Trends in Image Restoration and Enhancement \(cvlai.net\)](https://cvlai.net)
- [Image Super-Resolution \(x4\) Challenge @ CVPR 2023](#)



# Project 1: Deep Learning-Based Image Super-Resolution



Low-resolution



x4 super-resolution  
Method 1



x4 super-resolution  
Method 2



# Project 1: Deep Learning-Based Image Super-Resolution

- The following is a deep neural network called SwinIR. It utilizes **transformer** structures to do image super resolution.

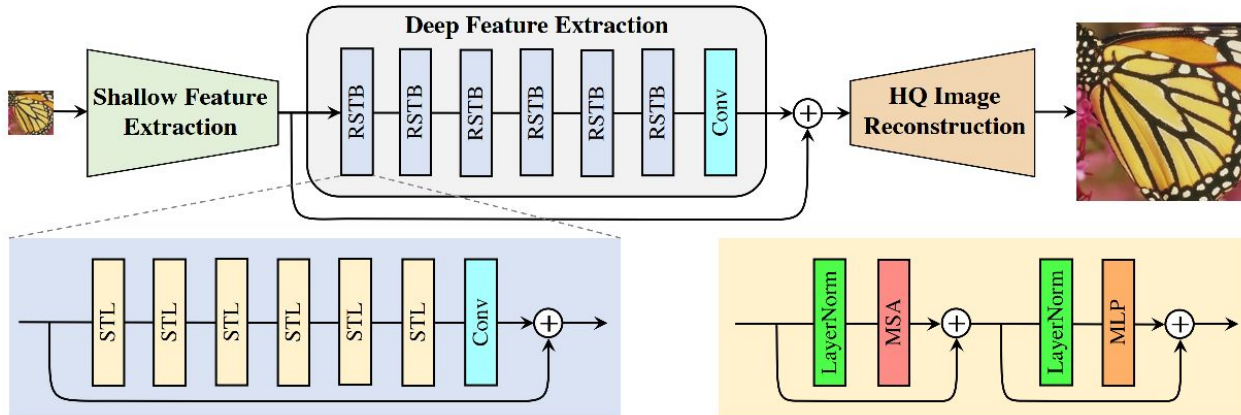



## Project 2: 360° Omnidirectional Image Super Resolution

- The 360° or omnidirectional images can provide an immersive and interactive experience and have received much research attention with the popularity of AR/VR applications.



x 4  
Super  
resolution



- [360° Omnidirectional Image Super-Resolution Challenge @ CVPR 2023](#)







# What will you gain from these projects?

- Extensive knowledge of image processing, deep learning, neural networks
- Deep learning programming skills using graphic processing unit (GPU), tensorflow, pytorch, etc.



# What will you gain from this project?

- Opportunity to participate in [the Computer Vision and Pattern Recognition \(CVPR\) Challenge](#) and gain hands-on experience in visual data processing and programming
- CVPR: the most prestigious conference in the field of computer vision in the world
- Experience in participating in a CVPR Challenge adds good credit to your future job hunting and graduate school application



SANTA CLARA UNIVERSITY  
SCHOOL OF ENGINEERING

18.JUNE VANCOUVER, CANADA

# NTIRE 2023

New Trends in Image Restoration and Enhancement workshop and associated challenges  
in conjunction with CVPR 2023

CALL FOR PAPERS

IMPORTANT DATES

NTIRE2022

MAI2022

AIM2022

This year we have a senior design team participating in the CVPR Challenge for image super-resolution.

You have the opportunity to participate in the 2024 Challenge.



SANTA CLARA UNIVERSITY

SCHOOL OF ENGINEERING

# Interested in it or would like more information?

- Contact Dr. Ying Liu at [yliu15@scu.edu](mailto:yliu15@scu.edu)

- **Shiva Jahangiri**



# Information Integration and Database Design for Entrepreneurship Apps

**Prof. Shiva Jahangiri**  
**[sjahangiri@scu.edu](mailto:sjahangiri@scu.edu)**

**April 24, 2023**



# #1. Data Management on the Web

- ❖ Same entity in multiple places, unintegrated information! □ Deep Web!
- ❖ Integrate information about the same/related entity (people/shops/services/anything(!)) from different websites into one app!

- ❖ Data Ingestion
- ❖ Data Cleaning
- ❖ Schema Creation & Data Integration
- ❖ App Development
- ❖ Data Visualization and Data Analysis

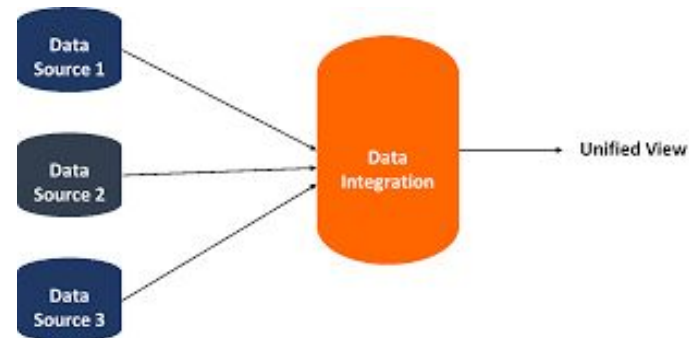

Image Credit Alibaba Cloud Community

Example: Collect information about job postings, required skills, and salaries to guide better what skills should a job seeker earn to amplify their chance for getting into the company that they desire.



# #1. Data Management on the Web

## Required skills

- Python & its libraries for data scrapping (Beautiful Soap, Selenium)
- App Development
- Database Design (Nice to have)

## Where you start

- From the scratch since it will be your idea!





## #2. Natural Language to SQL/SPARQL Translator

- ❖ **We are almost breathing data, but we don't speak its language, yet!**
- ❖ **Idea: Create a Natural Language to SQL/SPARQL Translator So a Database Can Understand Our Language!**
  - ❖ Useful for people without database background



## #2. Natural Language to SQL/SPARQL Translator

### Required skills

- Programming in Java or Python
- Being Familiar with SQL

### Where you start

- We already have databases and triple stores understanding SQL and SPARQL

- **Sean Choi - slides added May 2023**



SANTA CLARA UNIVERSITY

SCHOOL OF ENGINEERING

# Networking, ML & GPT

**Sean Choi**  
**sean.choi@scu.edu**

**April 17, 2023**



# Novel SmartNIC Accelerated Applications

- **SmartNICs are new type of network interface card that can run many different programs**
  - Best suited for simple, repeated tasks
  - Think of it as another hardware for accelerated compute, similar to GPUs!
- **Not a lot of fun applications have been built for it yet**
- **Let's come up with fun and new applications that can run on SmartNICs**
  - **Some examples**
    - Image / Video Processing Application: TikTok filters?
    - Blockchain: Mining / Blockchain transaction
    - Consensus protocols:
    - Databases: Key-value storage, NoSQL DB
    - Data processing: Machine learning acceleration
    - Many More!



# Novel SmartNIC Accelerated Applications

## Required skills

- Networking
- C/C++

## Where you start

- We can choose an application of interest together and scope out what to do



# Climate Change Detection via ML

- **How can we use ML to predict the climate and weather**
  - Storms
  - Floods
  - Droughts
  - Avalanches
  - Earthquakes
  - Fires



# Climate Change Detection via ML

## Required skills

- Machine Learning
- Programming (Language Agnostic)

## Where you start

- Select a phenomenon to predict
- Gather Data
- Build models and iterate





# GPT Applications

- **Detecting GPT Usage**
- **Detecting faulty information from GPT**
- **Generating valid data sets using GPT**
  - Can we use GPT to generate valid data sets



# GPT Applications

## Required skills

- Machine Learning
- Programming (Language Agnostic)

## Where you start

- Select a sub topic
- Gather Data
- Build models and iterate

